

| USER MANUAL

Tips: Please read this manual carefully before use and keep it properly.
Do not ride until you know the performance of this product.

2.Products and accessories

User information

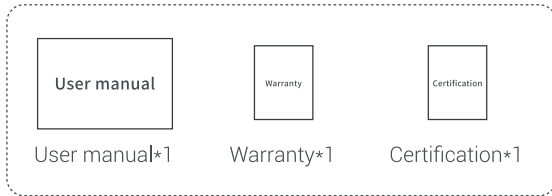

Accessories

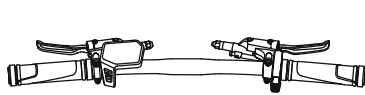

Handlebar assembly*1



Saddle*1



Key*2



Tool*3

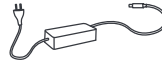

Charger*1

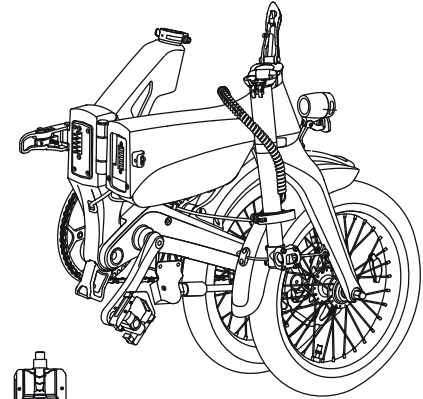

Pedal*1

Bike body*1

Please carefully check whether the items in the packaging box are complete and in fact of any missing or broken items.

3.Function diagram

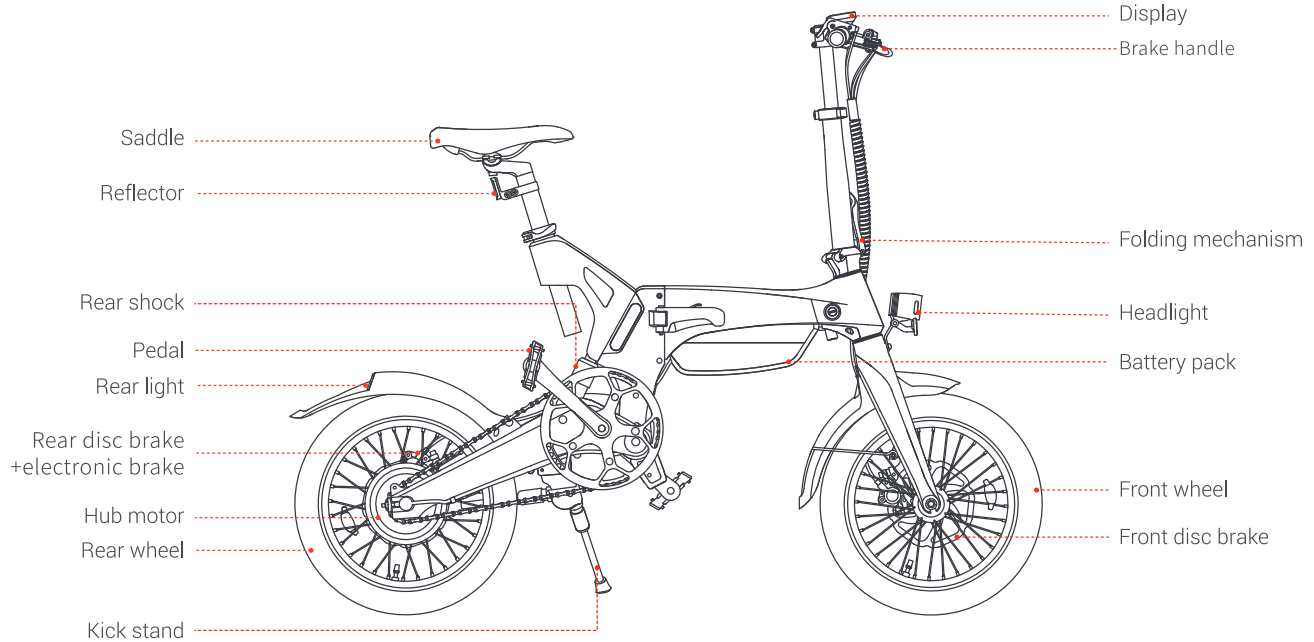



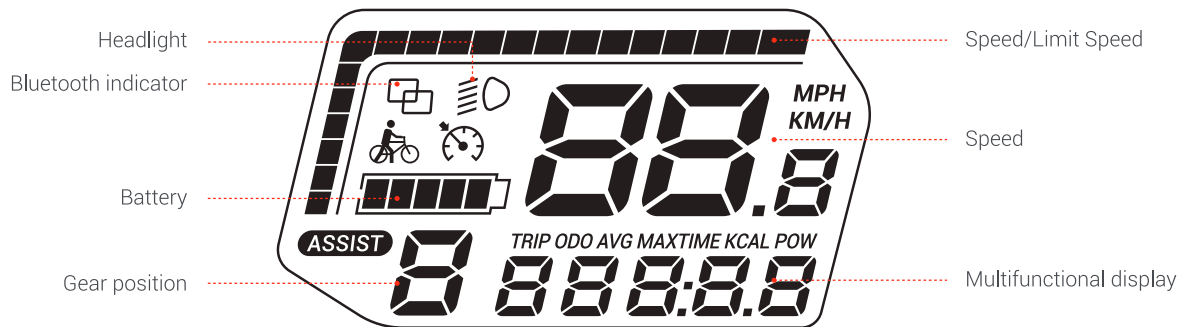

Display

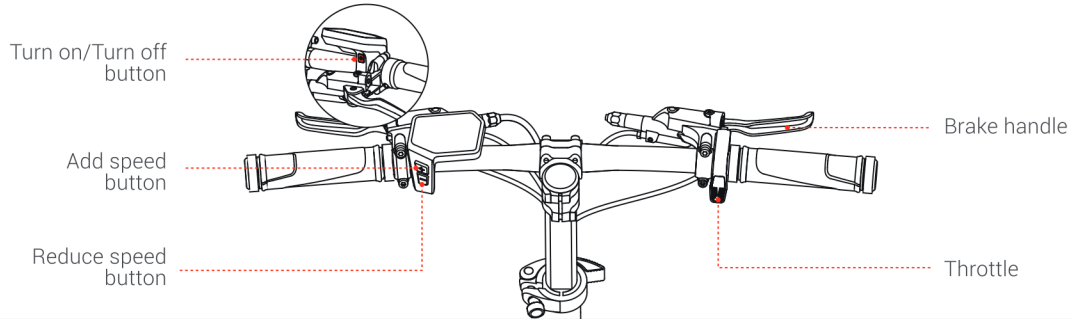

	Battery	Battery power is displayed in five bars. When the battery is fully charged, all five bars lights are on. When the battery is under voltage, the outer frame of the battery flashes, indicating that the battery needs to be charged immediately.
ERROR	Error code	When the electric bike electronic control system fails, the instrument will automatically display the error code, which will be displayed in the mileage digital segment in the format of E0**. The detailed definition table of the error code is shown on page 20 of this manual.
		When the display interface appears error code, please timely troubleshoot, after the failure of the electric bike will not be able to run normally.

Head combination switch



	Turn on/ Turn off button	Long press to start working and power the controller. In the boot state, long press the button to turn off the power supply. Short press the key display information switches between the total mileage (km), single mileage (km), maximum speed (km / h), and average speed (km/h).
	Add speed button	Long press to turn on the headlight, the display backlight dimmed. Long press the key again to turn off the headlights and the display backlight restore brightness. Short press Add speed button/Reduce speed button to switch the power gear of the electric bike, so as to change the output power of the motor.
	Reduce speed button	Long press the key, the electric bike into the state of push. The electric bike drives at a constant speed of 6 km/h, while the screen displays P gear. Release the key and the electric bike will immediately stop power output and return to the state before the booster push.

⚠ In the factory default setting, if the electric vehicle is not used for more than 10 minutes, the instrument will automatically shut down.

4.How to assembly

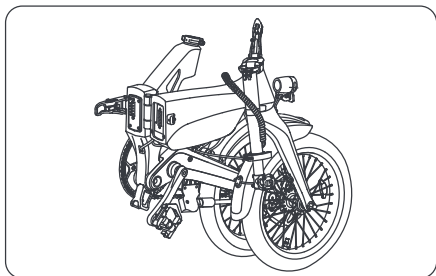

1. The bike is folded when taken out.

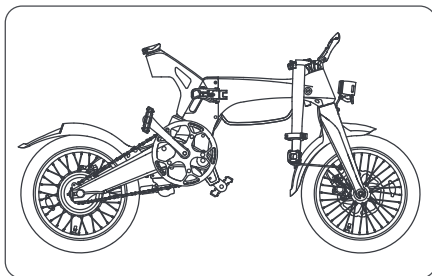

2. As shown in the picture, expand the body.

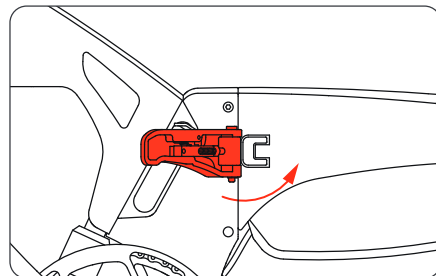

3. As shown in the picture, the folding latch is rotated towards the body and tightly buckled.

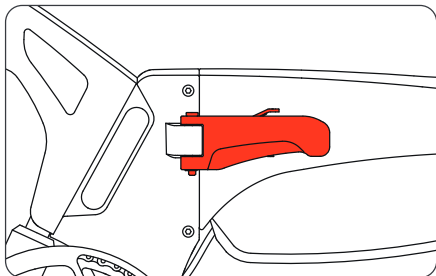

4. Check that the latch is fully closed and that the body is fixed firmly.

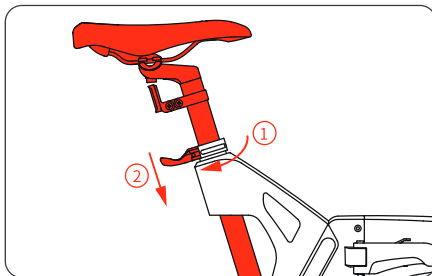

5. When installing the saddle, rotate the fixed latch ① outward to open, and then insert the saddle ② into the seat tube.

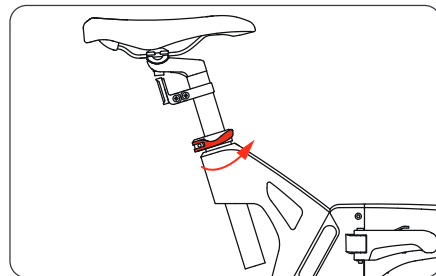

6. Rotate the latch in the indicated direction to tighten it. Please check that the saddle does not roll back or shake when pressed.

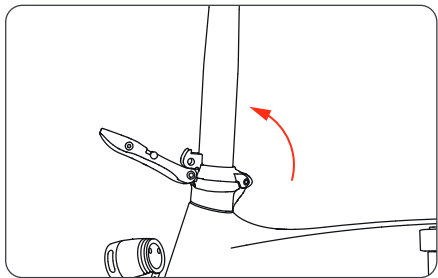

7. Lift the stem to an upright position in the direction shown in the picture.

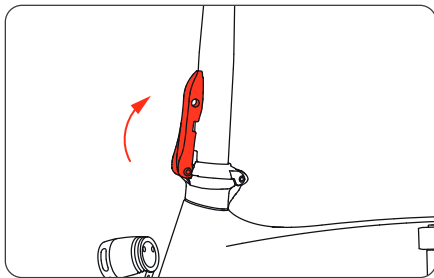

8. Tighten the fixed latch by rotating it toward the stem. Check that the latch is fully closed and that the stem is firm and not wobbly.

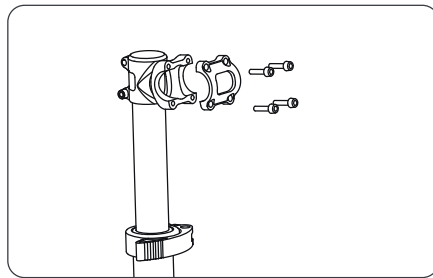

9. To secure the bar, unscrew the four screws on the slot with a wrench. Unscrew the screws as shown in the picture above.

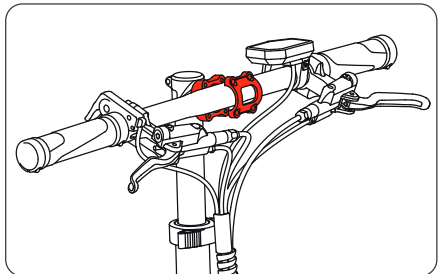

10. The corresponding slot position of the horizontal bar will be fixed.

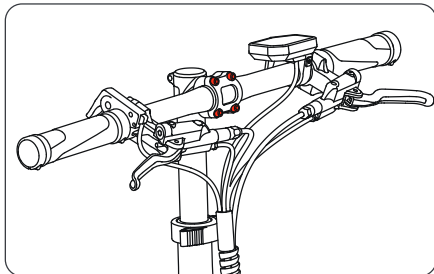

11. Fix the bar and tighten the screws with a hexagon screwdriver, as shown in the picture above.

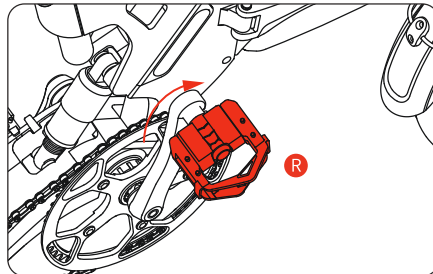

12. Install the pedal, turn the right foot clockwise and slowly spin in, tighten it with a wrench, so as not to cause slippery teeth.

5. Check before riding

To reduce the occurrence of accidental injuries, the following items should be checked before each ride:

1. Check bike status, tire and brake effect, etc. Ensure that no parts including the handlebars, risers, tires, brake lines, brake handles, fenders, and screws show any signs of loosening or damage.
2. When the power is low, the electric bike / scooter does not have enough power to maintain normal cycling. Please make sure that the power is sufficient to avoid danger.
3. Must wear a helmet and a full set of knee pads, wrist pads, elbow pads, wear sports shoes, and wear clothes suitable for sports. Long hair or enough to affect the line of sight bangs, broken hair should be tied up, so as not to block the line of sight affect normal riding.
4. For your first ride, please do not choose the areas where children, pedestrians, pets, vehicles or other obstacles and potential hazards may occur.

Note: If there are any abnormal signs, please stop using it immediately and contact the after-sales service for testing guidance.

6. How to ride



Helmet

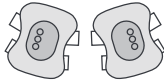

Protective

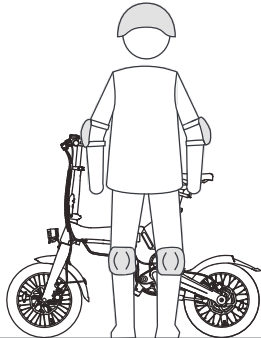

1. Preparation: There is a risk of falling and injury, so wear a helmet and protective gear all the time.

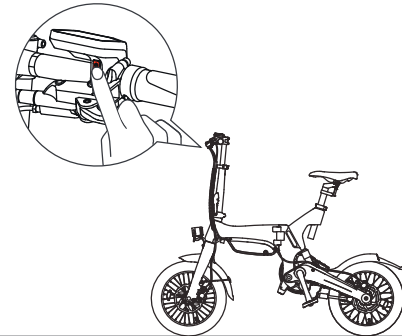

2. Operating: Press on/off to unlock and power on; and check battery status, if the charge is too low, please charge it immediately.

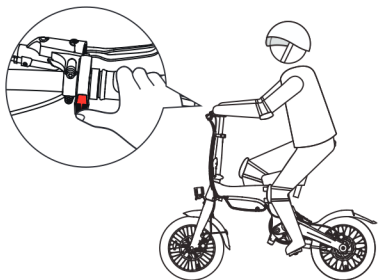

3. Start: Adjust the sitting position, slowly press the accelerator at speed gear; pedal it after balancing.

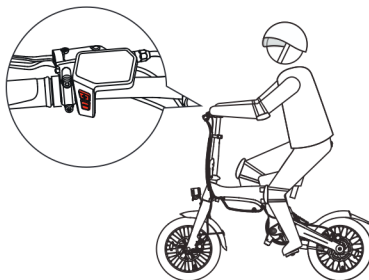

4. Gear Switching: Acceleration gear and deceleration gear can be 0 to 3 gear changes.

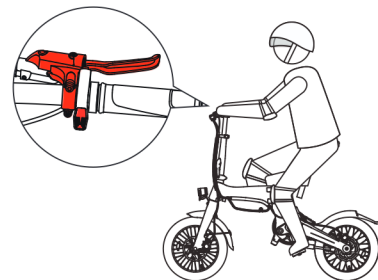

5. Slow down and brake: Release the throttle and slow down. Emergency brake requires a quick press on the brake lever.

Warning: Quick braking may fall due to insufficient.

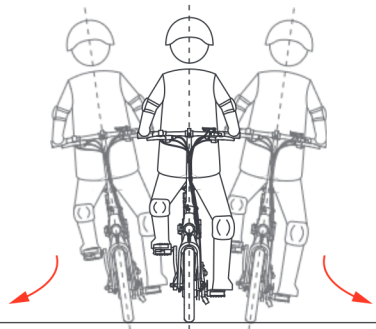

6. Turning: When turning, lean your center of gravity slightly and slowly turn your handle.

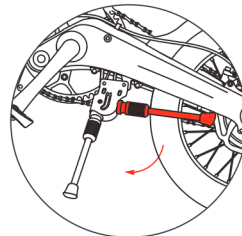
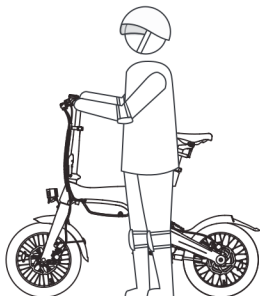

7. Get off: After cycling, please park the bike on the flat road and long press on to turn off the power; drop the foot support to avoid slipping or falling.

Folding method

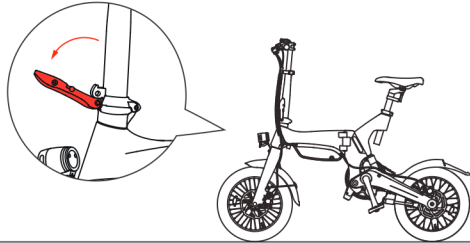

1. With the bike powered off, rotate the retaining buckle down.

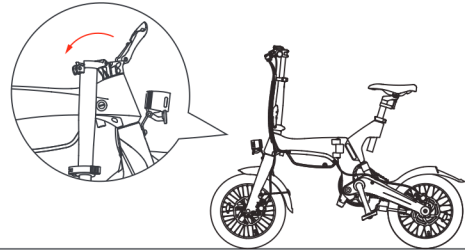

2. The stem can be rotated in the direction as shown in the picture when the fixing buckle is opened.

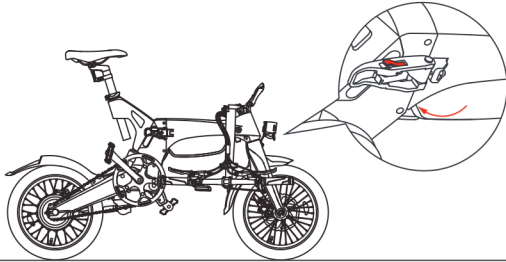

3. On the right side of the bike, press the folding button down and open the folding buckle by rotating outward.

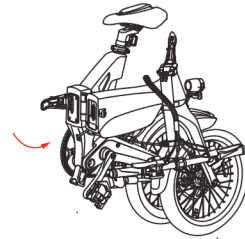

4. Rotate the front part of the bike body to the direction shown in the picture, and the bike is folded.

7.How to charge

Due to battery self-consumption during transportation and storage, it is normal for the battery to be low or no battery when used for the first time. Please charge according to the following charging steps. You can choose two ways for charging: outside charging and whole vehicle charging. Do not allow minors to use the charging equipment.

① Whole vehicle charging

Find the charging port on the left side of the battery box, open the rubber plug of the charging port, connect the output of the charger to the charging port of the body, and then connect the power. After charging, buckle the rubber plug.

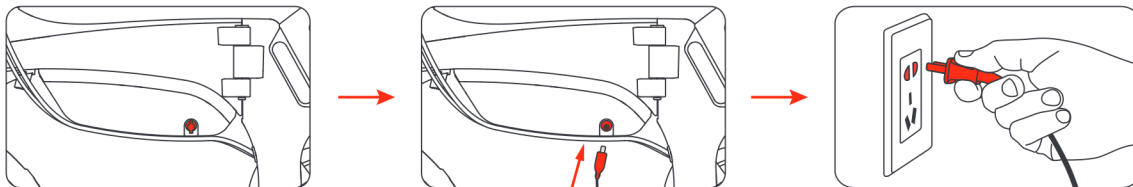

② External charging

Take out the battery, find the charging port, open the rubber plug of the charging port, first connect the output end of the charger to the charging port of the body, and then connect the power supply. After charging, buckle the rubber plug.

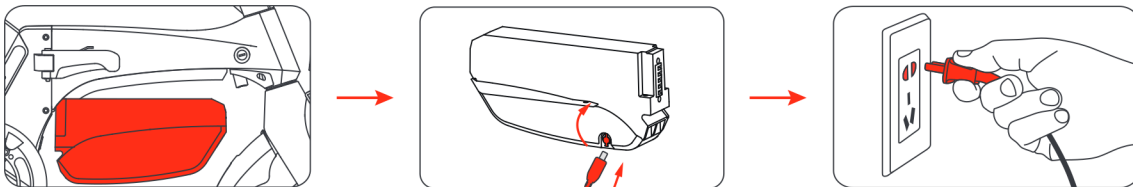

*The red light of the charger means the charger is working. The green light means the charging is finished. Please cut off the power after the battery is fully charged. If the temperature of the vehicle body exceeds 40 C , the vehicle will not be charged normally. Please wait until it drops below 40 C before charging.

⚠ Warning

1. Please charge when the vehicle power off.
2. Please use the original charger to charge, only use the charger designated or approved , otherwise the battery may be damaged or in danger of fire.
3. Do not charge when the charging port, power socket or charging line is wet. If the vehicle is flooded, the battery is damaged or flooded, it is prohibited to charge or continue to use the battery.
4. In the process of charging, if the indicator light is abnormal or there is abnormal smell, stop charging immediately and contact the after-sales service or replace the charger.
5. The charger shall be kept away from inflammables and explosives when working. The charger is not a toy. Please place it in a safe place where child cannot touch.
6. Disconnect the power immediately after charging. Do not connect the charger to the power supply for a long time when it is not charged.
7. It is necessary to regularly check whether the charger wire, plug, shell and other parts are damaged, and stop using it if it is found to be damaged, until it is repaired or the charger is replaced.

Battery disassembly method

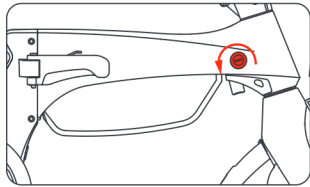

1. Use the special key to lock/open the battery lock on the bike body.

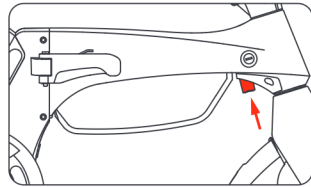

2. Press up the battery safety button.

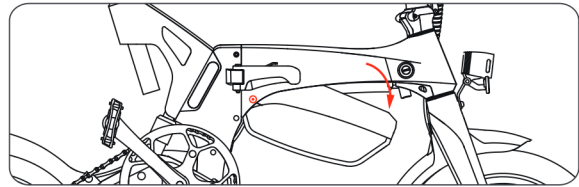

3. At the same time, hold the battery box, rotate a certain angle around the rotation point, and pull out the battery from the bottom of the front body.

8.Product specifications

Model	Light-P2 Pro
Colour	Dark gray/White/OEM
Maximum battery capacity	36V 10.5AH
Range	35KM
Motor	36V 250W
Tire	16*1.95 inches
Standard working voltage	36V
Battery type	Lithium battery
Brake	Front and rear disc brake
Rated maximum load	100KG
Lights	LED
Net weight	20KG
Gross weight	24.9KG
Unfolded size	1360*570*1090MM
Folded size	695*515*715MM
Storage temperature	0°C~35°C
Charging temperature	10~35°C

You can choose the appropriate version according to your own needs, and in the future Light-P2 Pro will launch various optional upgrade accessories and color style kits, please consult your dealer for details.

9. Daily maintenance

Users should obey the following tips to maintain electric bicycles:

Clean

Wipe the main frame clean with a soft damp cloth. For hard-to-clean stains, use a professional cleaner to scrub repeatedly, then clean with a soft damp cloth.

Note: Do not use alcohol, gasoline, kerosene or other corrosive and volatile solvents to clean. These substances may damage the exterior and interior structure of the vehicle body.

⚠ Warning

- Do not use pressure water guns or hose sprays for flushing.
- During the cleaning process, keep the electric bicycle turned off, unplug the charging cable and fasten the rubber cover of the charging port, otherwise it may cause electric shock or serious failure due to internal water.

Storage

When not in use, try to store it in a dry and cool place indoors, and try to avoid storing it outdoors for a long time. Sun exposure/hot/cold outdoor conditions will accelerate the aging of the appearance and tires and reduce the service life of the body and its battery pack. Before storing, please fully charge the electric bicycle, if it is not used for a long time, please charge it regularly to prevent the battery from discharging. Do not store it in a dusty environment to avoid damage to electrical components. Can not be stored together with chemicals, acids, alkalis and other substances.

⚠ Warning Do not go near the fire source!

Move

Before moving, make sure that the electric bicycle is turned off. During the handling process, please handle with care, do not throw, heavy pressure, rain, moisture and violent collision are strictly prohibited.

Battery Maintenance and Recycling

A well-maintained battery will keep running well even after many miles of driving. Generally speaking, a fully charged battery will use up its stored power in 120-180 days after it is turned off. If it is not used for a long time, it should be charged every 30-60 days. Charge the battery after each drive. A completely depleted battery may cause permanent damage. There is a smart chip inside the battery to record the charge and discharge of the battery. Damage due to over charging or undercharging is not covered under warranty.

- Do not remove or disassemble the battery.
- Do not use other types or brands of battery packs, otherwise there may be safety risks.
- It is forbidden to charge in areas prohibited by the laws of the country/region and relevant management units.
- Do not touch the battery contacts and do not open or puncture the case. Avoid metal objects touching the battery contacts to cause a short circuit, otherwise it may cause battery damage or personal injury.
- Do not throw the battery pack into a fire, otherwise it may cause the battery to fail, overheat, or even risk a fire.
- When storing or charging the battery, do not exceed the specified temperature limits (see "Product Specifications").
- Improper disposal of used batteries may seriously pollute the environment. Waste batteries cannot be disassembled without authorization, and should be recycled by relevant professional departments. Please abide by local regulations and do not discard the battery pack at will, so as to protect the natural environment.

Charger

- Chargers should be used exclusively for vehicles, and it is strictly forbidden to charge non-rechargeable batteries;
- Confirm whether the connected power is 110V-220V AC power;
- If you find damaged lines or loose connectors, do not use them, please contact the after-sales service or designated authorized service;
- When charging, the vehicle should be in a safe place, be ware of rain and sun exposure;
- When charging, insert the vehicle's charging port first, then the charger's power plug;
- During the charging process, if the indicator light is abnormal, there is a strange smell or the charger case is overheated, the charging should be cut off immediately;

- After the battery is fully charged, cut off the power supply of the charger first, then unplug the charger;
- After the charger has cooled down, tidy up the power cord and charging cable and place them in a safe place;

Other

- When the brake cable is loose or the brake is not sensitive, the brake cable screw can be adjusted.
- The external cord of the charger cannot be replaced. If the cord is damaged, please replace the charger in time.
- Tire repairs should be performed by professional service personnel.

Self Maintenance Guide

1. The first maintenance shall be carried out 1000 km after delivery of the new bike or 3 months after delivery (whichever comes first).
2. After the first warranty, it is recommended to maintain once every 2000 km or 6 months (whichever comes first).

Specific maintenance rules and items and requirements

Maintenance project	Maintenance time (month)	3	9	15	21	27	33
	Maintenance mileage (km)	1000	3000	5000	7000	9000	9000
Adjust or replace front and rear brakes		A	A/R	A	A/R	A	A/R
Check handlebar steering		C	C	C	C	C	C
Check the tire pressure		C	C	C	C	C	C
Check the disc brake system		C	C	C	C	C	C
Tighten main component		T	T	T	T	T	T
Lubrication of main parts		L	L	L	L	L	L
Front and rear suspension adjustment		A	A	A	A	A	A
Check light system		C	C	C	C	C	C
A: Adjust C: Check L: Lubricate T: Tighten R: Replace							

Error code meaning sheet

Error code	Malfunction	Error code	Malfunction
0x09	Abnormal current or MOS tube damage	0x02	Abnormal brake
0x08	Throttle error	0x06	Undervoltage
0x07	Motor error	0x30	Communication Error
0x14	Motor hall error		

10. Warranty service

1. Warranty parts

Type	Warranty parts	Time
Body frame	Frame	2 years
Spare parts	Battery, motor, controller, charger	1 year
Appearance delicate parts	Handles, front and rear fenders, crank chains, seat pads, brake pads	3 months

2. Non-warranty provision

1. Unauthorized maintenance, misuse, collision, negligence, abuse, liquid entry, accident, change, incorrect use of accessories other than this product, or tear, change or anti-counterfeit labels;
2. The warranty period has expired;
3. Damage caused by force majeure;
4. It does not meet the conditions of performance failure listed in the following "Electric Bike Performance Error Sheet";
5. Failure to use, maintain and adjust in accordance with the requirements in the "Instruction Manual" will lead to performance failure of e-bike;
6. Damage caused by human causes (including but not limited to punctured tires, collisions, marks and damage caused by normal use of appearance delicate parts, etc.);
7. Failure and damage caused by abnormal use of the product (including but not limited to overload, stepping down, falling, extreme sports, etc.);
8. If the product is used for commercial purposes, there is no warranty.

3. Electric Bike Performance Error Sheet

Product	Performance Error
Electric Bike	1. The motor can't work during normal use; 2. The controller is faulty during normal use; 3. The charger error during normal use; 4. The battery is error during normal use;

